

CITRINE MICRO-MINI-MIDI

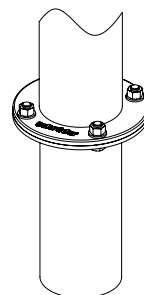

ENG	The light source fitted in this luminaire shall only be replaced by a Schröder employee or agent or a similar qualified person.	UKR	Джерело світла, встановлене в цей світильник, підлягає заміні лише працівником чи агентом компанії Шрєдер або аналогічним кваліфікованим фахівцем.	NLD	De lichtbron in dit verlichtingstoestel zal alleen vervangen worden door een medewerker, agent of vergelijkbaar gekwalificeerd persoon van Schröder	ROM	Sursa de lumină încorporată în acest aparat de iluminat va fi înlocuită doar de către un angajat al Schröder, de un agent al companiei sau de o persoană cu calificări similare.
SPA	La fuente de luz instalada en esta luminaria sólo puede ser substituida por Schröder o un agente cualificado.	ITA	La sorgente luminosa montata in questo apparecchio potrà essere sostituita esclusivamente da un addetto Schröder o da una persona parimenti qualificata.	DEU	Die eingebaute Lichtquelle in der Leuchte sollte nur von einem Schröder Mitarbeiter oder Vertreter oder einer ähnlichen qualifizierten Person ersetzt werden.	HUN	A lámpatestbe szerelt fényforrás (LED-modul) cseréjét csak a gyártó, annak szerviz szolgálatá, vagy erre kiképzett szakember végezheti!
FRA	La source de lumière intégrée dans ce luminaire peut uniquement être remplacée par un employé de Schröder, un agent ou une autre personne qualifiée.	POL	Źródło światła zamontowane w tej oprawie może być tylko wymienione przez pracownika Schröder lub przez inną wykwalifikowaną osobę.	POR	A fonte de luz montada nesta luminária só pode ser substituída por um funcionário ou agente da Schröder ou por profissional qualificado autorizado para o efeito	SRP	Zamenu svetlosnog izvora ugrađenog u ovu svetiljku će izvršiti samo Schröder-ov radnik, ovlašćeni predstavnik ili slična stručna osoba.
CHI	该灯具内的光源仅可由施莱德员工、指定代理商或具备类似资质的人员进行更换	VIE	Nguồn sáng được trang bị bên trong bộ đèn này chỉ được thay thế bởi nhân viên Schröder hoặc đại lý hoặc người có trình độ tương đương.	RUS	Источник света, установленный в этом светильнике, должен заменяться только сотрудником Schröder, или специалистом аналогичной квалификации.	SLK	Výmena svetelného zdroja (LED modul) je možná len výrobcom, resp. len nim vyškolenými odborníkmi!

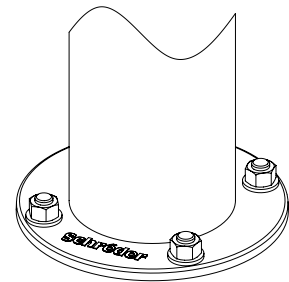
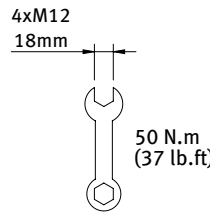
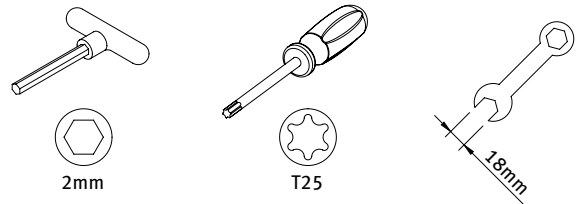
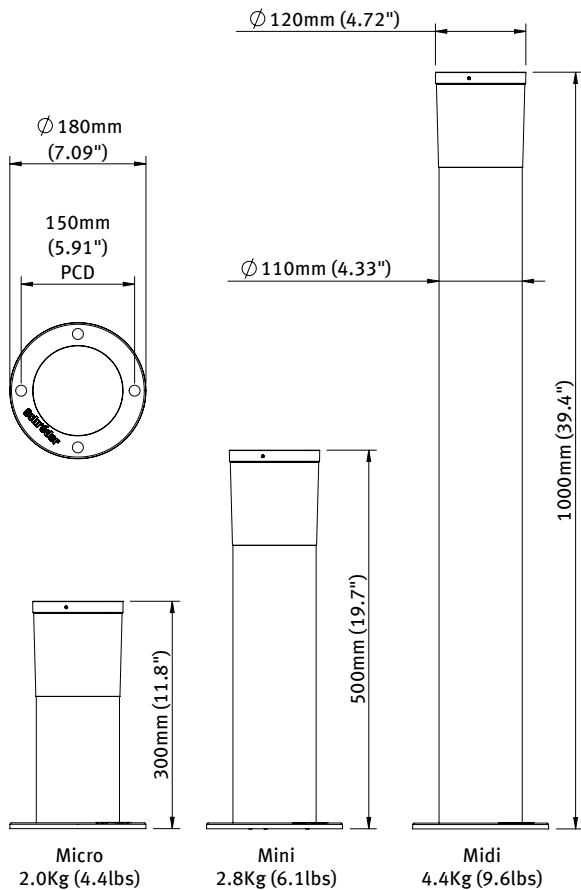

BOLT-ON ROOT

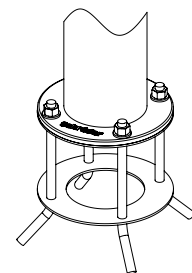

BOLT CAGE

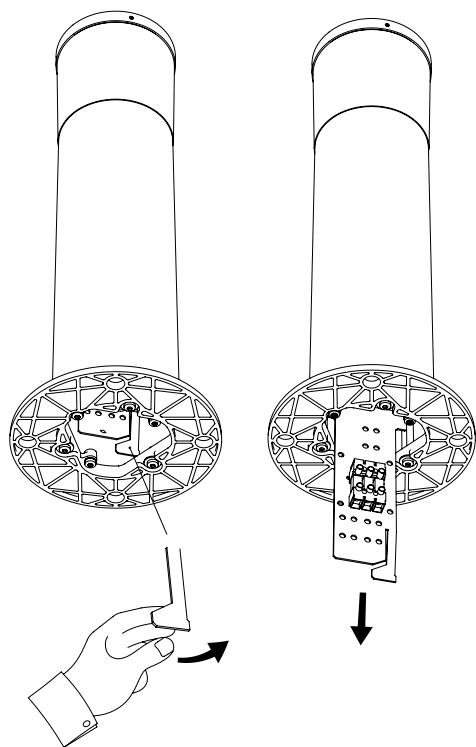
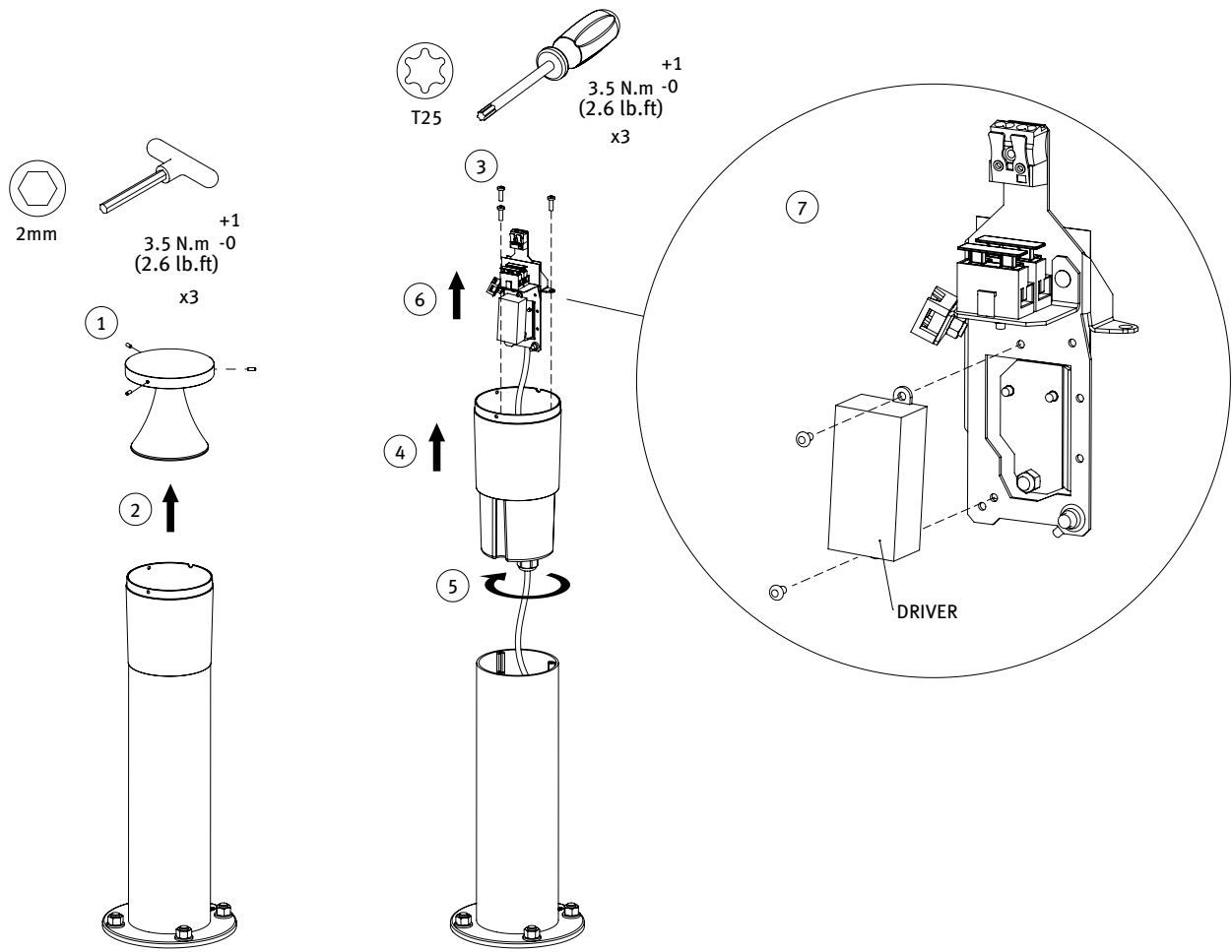

90-264 VAC 
90-305 VAC
50-60Hz

